

*Designer's*  
**NOTEBOOK**

## Series Enhances Selection Guide

This article presents the first in a series that serves as a sequel to the *Architectural Precast Concrete Color & Texture Selection Guide*. The series is designed to cover additional techniques affecting the design aspects of panel geometry or shape details (form). Its purpose is to broaden the architect's design repertoire by providing an understanding of concrete's plasticity and sculptural qualities.

Upcoming articles in the series, which will continue through 1998, will focus on cornices, reveals, sculptures, liners, veneers, lettering, returns and other architectural details.

PCI's Architectural Precast Concrete Services Committee outlines the potential of precast's moldability, repetition and use of bullnoses in the first of a series focusing on panel details

## Precast's Plasticity Enhances Design Options - Articles I & II

Precast concrete can replicate traditional shapes from the classical architectural vocabulary or produce the sleek contemporary look of today. To achieve these goals cost-effectively, however, requires working with the precaster and understanding the inherent advantages of the material so its use can be maximized. A key ingredient in that recipe comes in exploiting precast's low-cost repetition and its ability to cast many pieces from the same mold.

Costs naturally increase on a design as surface features become more extensive or intricate, as well as when the panel cross-section becomes more complex. However, the ability to cast many pieces from the same basic mold has made complex shapes economically feasible with precast concrete.

## Advantages Of Repetition

### Repetition and Mold Concept - Article I

Since molds typically are an expensive item, tooling costs should be spread over as many units as possible. The more elements that can be cast with any one given mold, the more economical the project becomes. Although every project will have some atypical conditions, the most successful and cost-effective projects maximize the repetition of elements. This means that careful planning is necessary to achieve good repetition without sacrificing design freedom.

Prior to designing wall panels, the architect should visit precasters who produce architectural precast concrete. If possible, the designer should visit the manufacturing plants, as well as projects underway. This way the designer can become familiar with the manufacturing process. Such elements as the fabrication of molds, challenges to casting and finishing specific designs or shapes, handling methods at the plant and jobsite, and approaches for connecting panels to a structure are important to fully understand in order to maximize precast's potential.

## Master Mold Efficiency

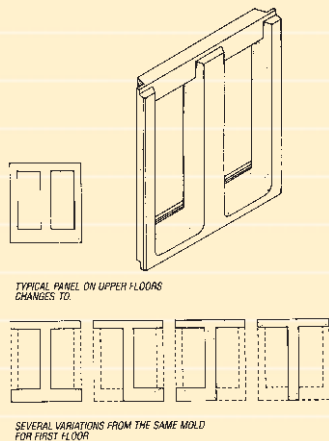

**Fig. 1A—Typical applications of the master mold concept.**

The architect can make a significant contribution to economic production by designing precast concrete panels with a knowledge of the “master mold” concept. This involves fabricating one master mold (with its appropriate additional tooling) that allows a maximum number of reuses per project. Units cast in this mold need not be identical, provided the changes in the units can be accomplished through pre-engineered mold modifications.

These modifications should be achieved with a minimum change-over time and without jeopardizing the usefulness or quality of the original mold. Typical applications are shown in

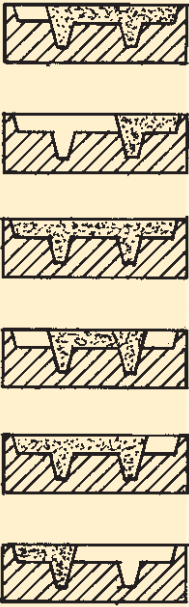

Fig. 1B—Several versions of a master mold.

Fig. 1A. It is relatively easy to alter a mold if the variations can be contained within the total mold envelope by using bulkheads or blockouts rather than by cutting into the mold surface. When a large number of precast concrete units can be produced in each mold, the cost per square foot will be more affordable.

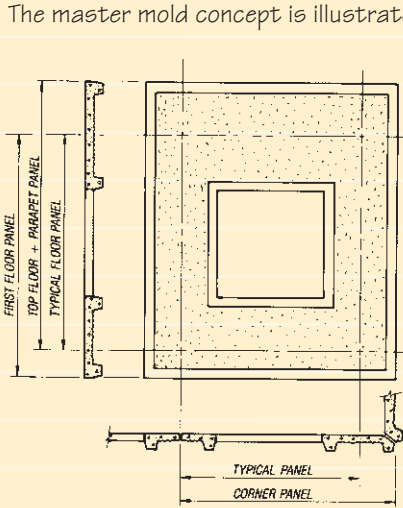

Fig. 1C—Three views of a master mold.

The master mold concept is illustrated in Figs. 1B and 1C. In these examples, a large number of panels (if not all of them) can be produced from a single mold built to accommodate the largest piece and then subdivided as needed to produce the other required sizes. Whenever possible, the largest pieces should be produced first to avoid casting on areas that have become worn and damaged by placing and fastening side-form bulkheads.

The number of forms required for a job is determined by the time allowed for completing the job and the facilities available. Casting may proceed

during the early part of the erection process if the panels have been manufactured in the correct sequence. However, this format may not coincide with the needs of the master mold concept. The number of forms also is affected by the original planning of the master mold. Fewer forms will be required if most conditions can be covered by modifying the master mold with bulkheads or blockouts.

**The Larger The Better**

Most precasters, for reason of economy, prefer to make precast units as large as possible within normal handling and shipping limitations. This is because the smaller the panel, the greater the number of pieces required for enclosure. Handling precast components constitutes a significant portion of the expense involved. The cost difference in handling a large rather than a small unit is insignificant compared to the increased square footage of the large unit.

In addition to providing cost savings during erection, larger panels provide secondary benefits by reducing the amount of caulking needed, offering better dimensional controls and requiring fewer connections. Thus, large units are preferable unless they lack adequate repetition or incur cost premiums for transporting and erecting.

**Moldability Advantages**

In addition to considering maximum form reuse, the final design should take into account ease of removal from forms. This allows the precaster to most efficiently meet schedules and budgets without impacting the design aesthetics.

Architectural concrete units normally are cast indoors in a horizontal or flat position with

the exposed, textured or sculptured face down (Fig. 1D).

Where the shape requires it, the form may be made in parts with removable sections (such as side rails and top forms) that must be assembled and disassembled with each day's pour (Fig. 1E and Fig. 1F).

The optimum economy in production is attained if the panel can be separated from the mold without disassembling

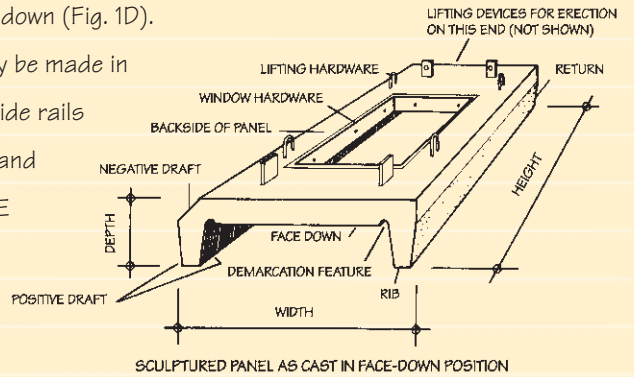

Fig. 1D—A sculptured panel as cast in a face-down position.

the mold (Fig. 1G). This is done by providing slope (draft) on the sides of all openings and

edges. Drafts are a function both of shape and production techniques.

Generally, the minimum positive draft that will allow the unit to be stripped from the mold easily is one inch in one foot (1:12), but 1:8 is preferred. This draft should be increased for narrow or delicate units where the suction between the unit and the mold becomes a major

Fig. 1E—Removable sections within a master mold.

factor in both strength requirements and reinforcement of unit. The draft should be increased to 1:6 for units pierced with many openings, for narrow ribbed panels and for smooth concrete and delicate units (Fig. 1H). Drafts for ribbed panels should be related to the depth, width and spacing of the ribs.

At areas where negative draft is required, it may be necessary to incorporate slip blocks (i.e., removable plugs) to aid in stripping the precast concrete panel from the mold (Fig. 1H). Reverse or negative draft will create entrapped air voids that, if exposed, may be objectionable. Minimizing these surface blemishes will incur extra cost. In general, the greater the draft, the more economical and uniform the finish.

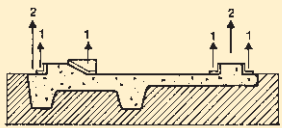

Fig. 1F—An envelope mold with haunches on the back.

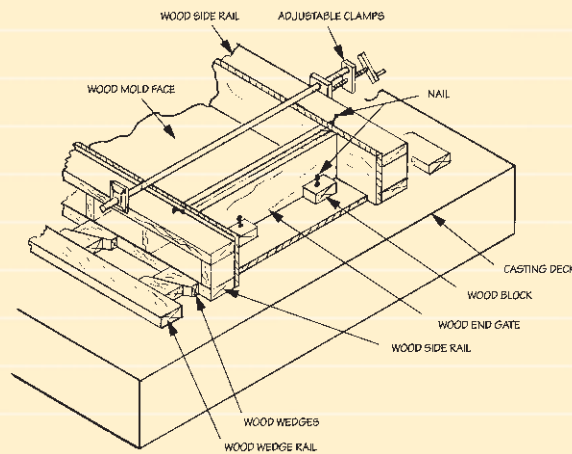

Fig. 1E—Removable sections within a master mold.

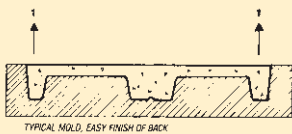

Fig. 1G—Economy is achieved if the panel can be removed from the mold without disassembling the mold.

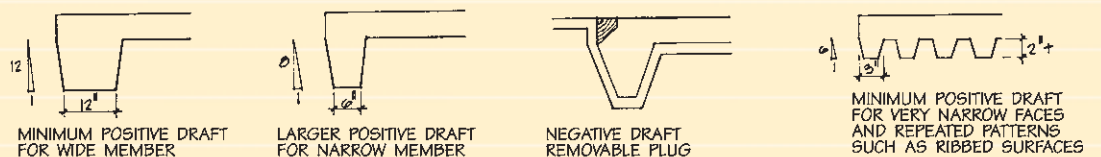
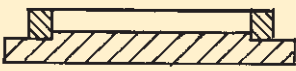

Fig. 1H—Draft should be increased from 1:12 to 1:6 for panels with special needs.



## Bullnoses/Arrises - Article II

### Bullnoses Add Interest



Typical flat mold.



Typical bullnose.  
Additional forming cost.

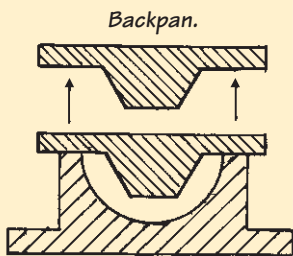

Total round bullnose.  
Complex basic mold plus  
backpan to be removed and  
replaced daily.

Fig. B-1—As the bullnose becomes more complex, the mold expense increases.

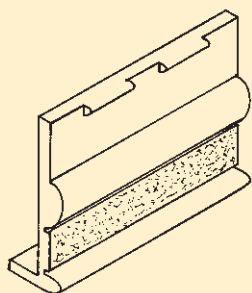

Fig. B-11—A bullnose featuring an interrupt.

The bullnose offers a useful tool with which architects can increase interest by adding dimensionality and allowing the design to avoid simple concrete planes. The light-and-shadow effect achieved with a bullnose produces a major visual impact when a building is viewed from a distance. Also, shadows cast by a horizontal bullnose profile create strong lines that reduce the apparent height of the structure.

Here are some key points to remember when designing bullnose components. For each item, the number corresponds to a Figure that shows the discussed aspect (e.g., 1.=Fig. B-1):

1. Bullnoses range in size from less than one inch to a total-radius panel. As the bullnose increases in size, it adds weight and cost to the panel, primarily due to the expense of the mold.
2. The basic bullnose is 180 degrees, or a half-circle.
3. Multiple bullnoses can be used within a panel.
4. The bullnose can be elliptical.
5. A rustication (i.e., reveal) may be placed at the intersection of the bullnose and the panel field to accentuate the bullnose. The reveal may also be used to separate dissimilar mixes and/or finishes.

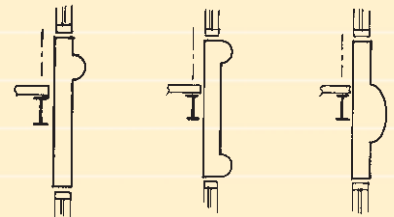

Fig. B-2—A typical bullnose.

Fig. B-3—A double bullnose.

Fig. B-4—An elliptical bullnose.

6. The bullnose may be halved.
7. A return may be incorporated with the bullnose.
8. The bullnose may be concave.
9. The bullnose may be convex.
10. The bullnose may be partial.
11. The bullnose may be interrupted, but this may have an impact on schedule and price due to form changes.

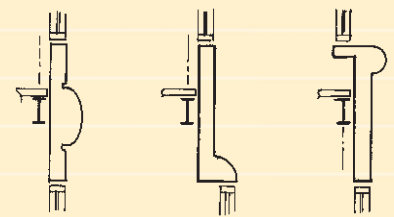

Fig. B-5—A bullnose with reveals at top and bottom.

Fig. B-6—A half bullnose.

Fig. B-7—A bullnose featuring a return.

12. Arrises (i.e., shapes) may be rectilinear or pointed. They may protrude or be inverted similar to items 1 through 11 above. They also may be combined with bullnoses.

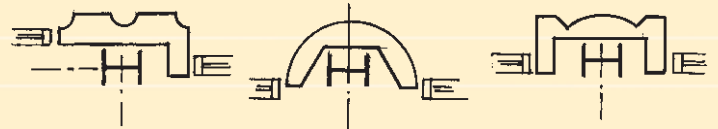

Fig. B-8—A concave bullnose.

Fig. B-9—A convex bullnose.

Fig. B-10—A partial bullnose.

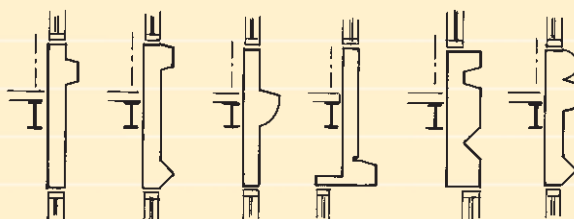

Fig. B-12—Arrises can take many shapes.

In all instances, the most effective design, along with efficient connection details, can be achieved by discussing these aspects with the precaster prior to finalizing the plans. They will be able to supply suggestions and designs that ensure that the maximum design efficiency is achieved at the lowest erected cost.

# Great Potential In Precast Bullnoses

Architect Anthony J. Lumsden explains a variety of ways he has used precast concrete bullnose components to give projects more aesthetic appeal

Many of the buildings I've designed as principal for design at DMJM and now as principal for Anthony J. Lumsden & Associates have incorporated precast linear elements that are rounded in section. Often, these precast pieces are designed with combinations of concave, convex and flat sectional shapes. Taking advantage of precast's plasticity in creating these shapes can add considerable aesthetic appeal to a project.

Bullnoses help add interest to many flat surfaces, especially those with no functional need or a minimal need for fenestration. These flat areas often lack scale and visual interest, and the introduction of bullnose precast sections can enliven them.

## Bullnoses Add Dimension

Their key advantage comes from the fact that three dimensional pieces that extend from a flat surface change the reading and proportion of that surface. Rectilinear shapes added to a flat plane may make the flat plane appear irregular and be visually disruptive. Curved surfaces, such as bullnoses, won't confuse the

organization of the total form. Their curved form offers a basically different shape in the geometry that is easily distinguished from the flat plane. The plane and the bullnose can modify each other without confusion.

Curved surfaces change direction in relationship to sunlight and the viewer.

Surfaces which change directions in plan or section relative to any light source, even

reflective light, express variations in illumination, reflectivity, shading and brightness. These light and shade variations produce visual interest and contrast. The sun's movement during the day introduces additional modification to this light and shading further changing the building's appearance. The fundamental appeal of the bullnose form in precast concrete design comes from its ability to visually reportion an uninteresting, flat surface.

The bullnose can also be used to develop more complex forms in combination with bullnose shapes of different radii or in combination of convex, concave or flat surfaces. Some architectural forms that are not flat can be difficult to achieve. However, forms which are cylindrical in nature, forms that have surfaces generated from a sectional shape which are consistent throughout the length of the form, are simple to form. These forms that are consistent sectionally allow multiple castings. These forms are economical to fabricate since attached pieces are identical and easy to install. Molded shapes that have curvatures about both axes are very difficult to fabricate, difficult to install and have limited repetitive



*Adding bullnoses along each window ledge of the Terminal Services Building at the Hyperion Wastewater Treatment Facility added variety to the design, improved the proportions of the facade, and created changing light patterns during the day.*



*The use of the bullnose sections on various support buildings at the Hyperion Wastewater Treatment Facility broke up the flat-panel facade and created a distinctive look.*



*Large bullnose components added to the parking structure at the Hyperion Wastewater Treatment Facility provided a distinctive visual element that tied it to the other buildings in the project without mimicking their exact look.*

applications. Forms which vary in radii in both axes, such as a warped plane, are extraordinarily expensive in fabrication and virtually impossible to install and maintain. This difference in reuse of the mold and ease of fabrication and installation is what distinguishes the bullnose form from many other nonlinear type forms.

The essence of the barrel form, which is basically a sliced extrusion, is that it can be fabricated and attached to a similar precast element simply and economically. Concrete allows for the economic use of three-dimensional forms that would be prohibitively expensive if they were cut from stone. Precasting allows these forms to be precisely controlled in accuracy of surface, shape and line and in consistency of color and texture.

## Facility Offers Examples

This combination of sectional geometries that extends horizontally to develop linear forms can be seen extensively on the Hyperion Wastewater Treatment Facility in Los Angeles. Bullnoses were designed under the windows at each floor level of the Technical Services Building. This changed the proportion of the opaque section of the facade, adding highlights on the upper curvature, shadows on the lower portions of the curved bullnose and shading on the flat spandrel surface.

The inclusion of bullnoses in the design illustrates how a surface can be modified to become better proportioned, more interesting and more visually organized. The bullnose design was used on a variety of other buildings in this project, including the Switchyard Building, the parking structure and several smaller support buildings on the Hyperion campus. This not only added visual interest but offered a continuity element that tied the separate structures together without mimicking one style.

On the Moscone Convention Center in San Francisco, the bullnose was used at the entry lobby interspersed with glazing and for the terraced garden on the 3rd Street facade. It was used to cap the planters and modify the proportion of the opaque service node.

These examples show only a few of the ways that bullnoses can provide design interest on a project. Its ability to break up the flat plane without disrupting its flow makes the bullnose a valuable weapon in the designer's arsenal of precast concrete design techniques.



*The lobby facade of the Moscone Convention Center makes ample use of bullnose sections, tying in with planters and adding visual interest to the center. (For another view of this project, see the Designer's Notebook cover, page 13.)*



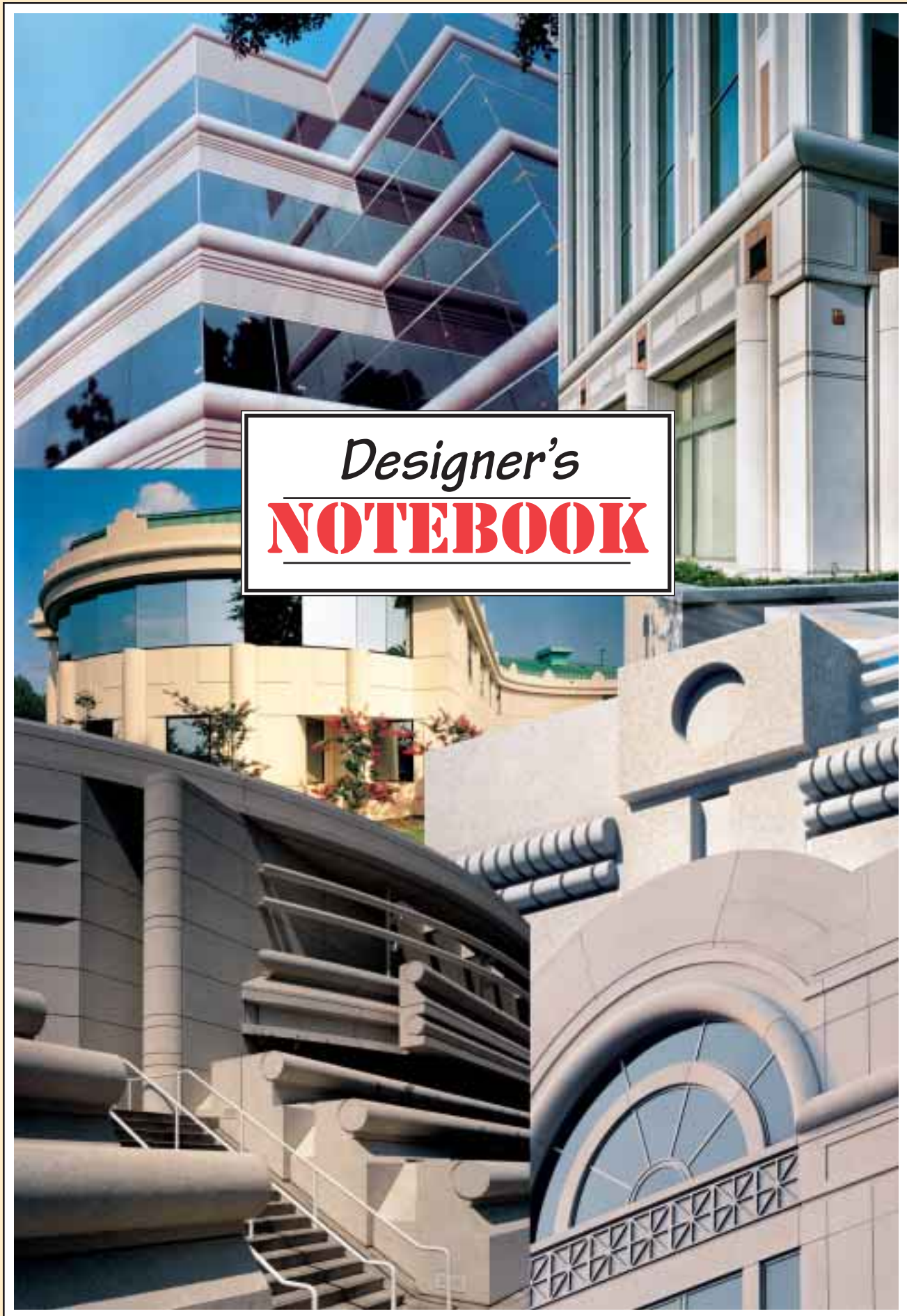

*Designer's*  
**NOTEBOOK**



## Series Enhances Selection Guide

This article presents the first in a series that serves as a sequel to the *Architectural Precast Concrete Color & Texture Selection Guide*. The series is designed to cover additional techniques affecting the design aspects of panel geometry or shape details (form). Its purpose is to broaden the architect's design repertoire by providing an understanding of concrete's plasticity and sculptural qualities.

Upcoming articles in the series, which will continue through 1998, will focus on cornices, reveals, sculptures, liners, veneers, lettering, returns and other architectural details.

PCI's Architectural Precast Concrete Services Committee outlines the potential of precast's moldability, repetition and use of bullnoses in the first of a series focusing on panel details

## Precast's Plasticity Enhances Design Options - Articles I & II

Precast concrete can replicate traditional shapes from the classical architectural vocabulary or produce the sleek contemporary look of today. To achieve these goals cost-effectively, however, requires working with the precaster and understanding the inherent advantages of the material so its use can be maximized. A key ingredient in that recipe comes in exploiting precast's low-cost repetition and its ability to cast many pieces from the same mold.

Costs naturally increase on a design as surface features become more extensive or intricate, as well as when the panel cross-section becomes more complex. However, the ability to cast many pieces from the same basic mold has made complex shapes economically feasible with precast concrete.

## Advantages Of Repetition

### Repetition and Mold Concept - Article I

Since molds typically are an expensive item, tooling costs should be spread over as many units as possible. The more elements that can be cast with any one given mold, the more economical the project becomes. Although every project will have some atypical conditions, the most successful and cost-effective projects maximize the repetition of elements. This means that careful planning is necessary to achieve good repetition without sacrificing design freedom.

Prior to designing wall panels, the architect should visit precasters who produce architectural precast concrete. If possible, the designer should visit the manufacturing plants, as well as projects underway. This way the designer can become familiar with the manufacturing process. Such elements as the fabrication of molds, challenges to casting and finishing specific designs or shapes, handling methods at the plant and jobsite, and approaches for connecting panels to a structure are important to fully understand in order to maximize precast's potential.

## Master Mold Efficiency

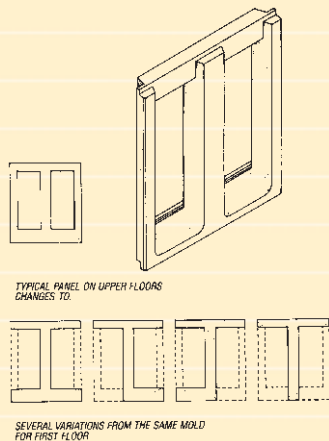

**Fig. 1A—Typical applications of the master mold concept.**

The architect can make a significant contribution to economic production by designing precast concrete panels with a knowledge of the “master mold” concept. This involves fabricating one master mold (with its appropriate additional tooling) that allows a maximum number of reuses per project. Units cast in this mold need not be identical, provided the changes in the units can be accomplished through pre-engineered mold modifications.

These modifications should be achieved with a minimum change-over time and without jeopardizing the usefulness or quality of the original mold. Typical applications are shown in

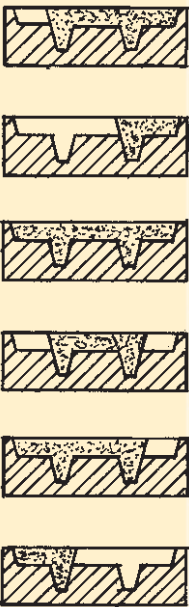

Fig. 1B—Several versions of a master mold.

Fig. 1A. It is relatively easy to alter a mold if the variations can be contained within the total mold envelope by using bulkheads or blockouts rather than by cutting into the mold surface. When a large number of precast concrete units can be produced in each mold, the cost per square foot will be more affordable.

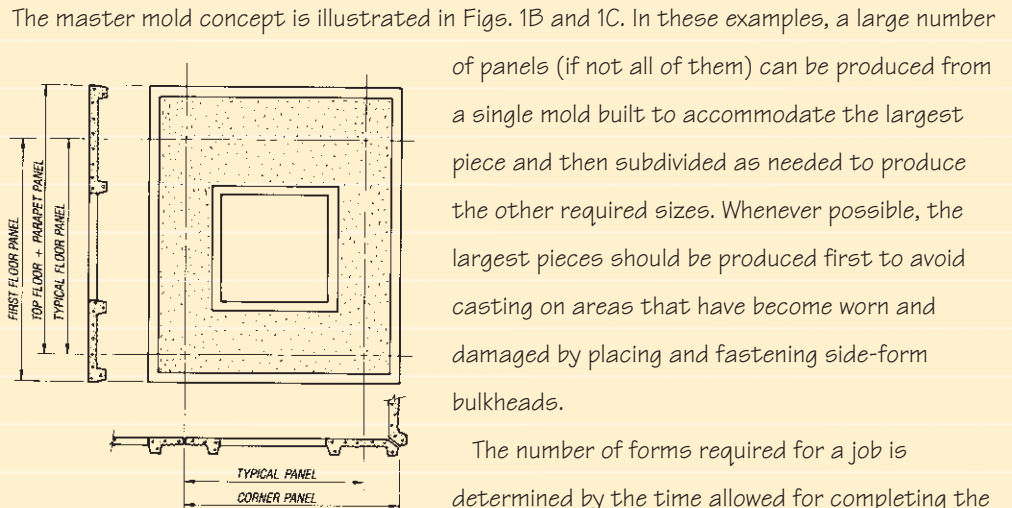

Fig. 1C—Three views of a master mold.

The master mold concept is illustrated in Figs. 1B and 1C. In these examples, a large number of panels (if not all of them) can be produced from a single mold built to accommodate the largest piece and then subdivided as needed to produce the other required sizes. Whenever possible, the largest pieces should be produced first to avoid casting on areas that have become worn and damaged by placing and fastening side-form bulkheads.

The number of forms required for a job is determined by the time allowed for completing the job and the facilities available. Casting may proceed

during the early part of the erection process if the panels have been manufactured in the correct sequence. However, this format may not coincide with the needs of the master mold concept. The number of forms also is affected by the original planning of the master mold. Fewer forms will be required if most conditions can be covered by modifying the master mold with bulkheads or blockouts.

### The Larger The Better

Most precasters, for reason of economy, prefer to make precast units as large as possible within normal handling and shipping limitations. This is because the smaller the panel, the greater the number of pieces required for enclosure. Handling precast components constitutes a significant portion of the expense involved. The cost difference in handling a large rather than a small unit is insignificant compared to the increased square footage of the large unit.

In addition to providing cost savings during erection, larger panels provide secondary benefits by reducing the amount of caulking needed, offering better dimensional controls and requiring fewer connections. Thus, large units are preferable unless they lack adequate repetition or incur cost premiums for transporting and erecting.

### Moldability Advantages

In addition to considering maximum form reuse, the final design should take into account ease of removal from forms. This allows the precaster to most efficiently meet schedules and budgets without impacting the design aesthetics.

Architectural concrete units normally are cast indoors in a horizontal or flat position with

the exposed, textured or sculptured face down (Fig. 1D).

Where the shape requires it, the form may be made in parts with removable sections (such as side rails and top forms) that must be assembled and disassembled with each day's pour (Fig. 1E and Fig. 1F).

The optimum economy in production is attained if the panel can be separated from the mold without disassembling

the mold (Fig. 1G). This is done by providing slope (draft) on the sides of all openings and

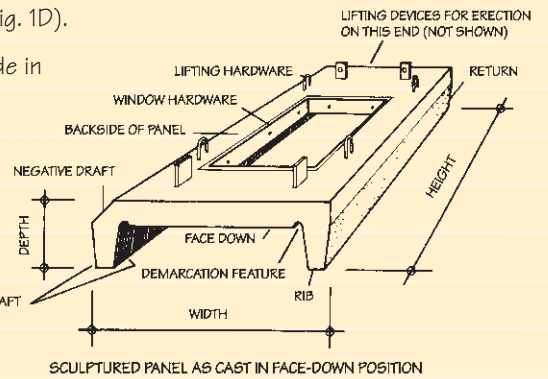

Fig. 1D—A sculptured panel as cast in a face-down position.

edges. Drafts are a function both of shape and production techniques.

Generally, the minimum positive draft that will allow the unit to be stripped from the mold easily is one inch in one foot (1:12), but 1:8 is preferred. This draft should be increased for narrow or delicate units where the suction between the unit and the mold becomes a major

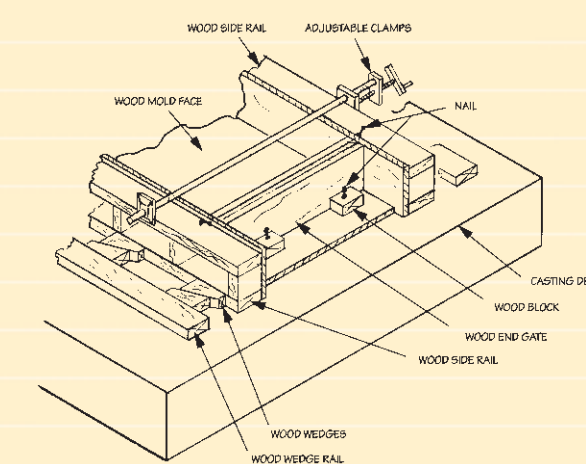

Fig. 1E—Removable sections within a master mold.

factor in both strength requirements and reinforcement of unit. The draft should be increased to 1:6 for units pierced with many openings, for narrow ribbed panels and for smooth concrete and delicate units (Fig. 1H). Drafts for ribbed panels should be related to the depth, width and spacing of the ribs.

At areas where negative draft is required, it may be necessary to incorporate slip blocks (i.e., removable plugs) to aid in stripping the precast concrete panel from the mold (Fig. 1H). Reverse or negative draft will create entrapped air voids that, if exposed, may be objectionable. Minimizing these surface blemishes will incur extra cost. In general, the greater the draft, the more economical and uniform the finish.

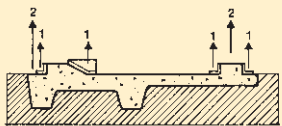

Fig. 1F—An envelope mold with haunches on the back.

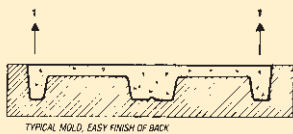

Fig. 1G—Economy is achieved if the panel can be removed from the mold without disassembling the mold.

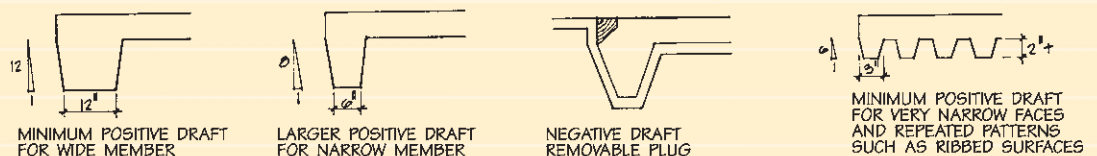
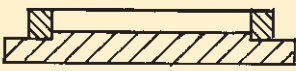

Fig. 1H—Draft should be increased from 1:12 to 1:6 for panels with special needs.

## Bullnoses/Arrises - Article II

### Bullnoses Add Interest



Typical flat mold.



Typical bullnose.  
Additional forming cost.

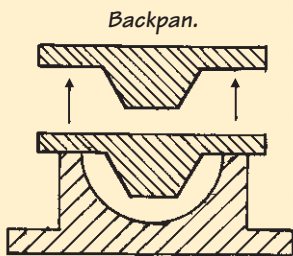

Total round bullnose.  
Complex basic mold plus  
backpan to be removed and  
replaced daily.

Fig. B-1—As the bullnose becomes more complex, the mold expense increases.

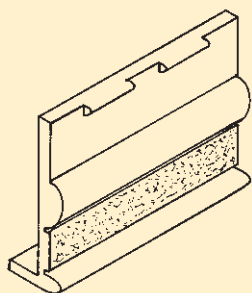

Fig. B-11—A bullnose featuring an interrupt.

The bullnose offers a useful tool with which architects can increase interest by adding dimensionality and allowing the design to avoid simple concrete planes. The light-and-shadow effect achieved with a bullnose produces a major visual impact when a building is viewed from a distance. Also, shadows cast by a horizontal bullnose profile create strong lines that reduce the apparent height of the structure.

Here are some key points to remember when designing bullnose components. For each item, the number corresponds to a Figure that shows the discussed aspect (e.g., 1.=Fig. B-1):

1. Bullnoses range in size from less than one inch to a total-radius panel. As the bullnose increases in size, it adds weight and cost to the panel, primarily due to the expense of the mold.
2. The basic bullnose is 180 degrees, or a half-circle.
3. Multiple bullnoses can be used within a panel.
4. The bullnose can be elliptical.
5. A rustication (i.e., reveal) may be placed at the intersection of the bullnose and the panel field to accentuate the bullnose. The reveal may also be used to separate dissimilar mixes and/or finishes.

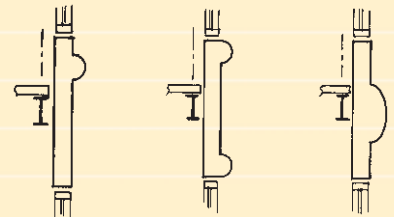

Fig. B-2—A typical bullnose. Fig. B-3—A double bullnose. Fig. B-4—An elliptical bullnose.

6. The bullnose may be halved.
7. A return may be incorporated with the bullnose.
8. The bullnose may be concave.
9. The bullnose may be convex.
10. The bullnose may be partial.
11. The bullnose may be interrupted, but this may have an impact on schedule and price due to form changes.

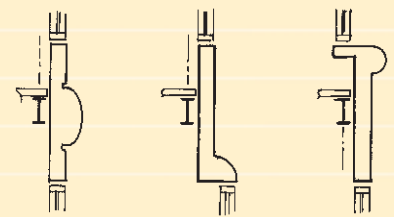

Fig. B-5—A bullnose with reveals at top and bottom. Fig. B-6—A half bullnose. Fig. B-7—A bullnose featuring a return.

12. Arrises (i.e., shapes) may be rectilinear or pointed. They may protrude or be inverted similar to items 1 through 11 above. They also may be combined with bullnoses.

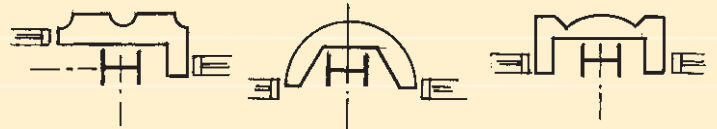

Fig. B-8—A concave bullnose. Fig. B-9—A convex bullnose. Fig. B-10—A partial bullnose.

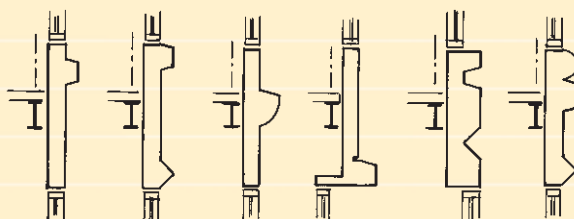

Fig. B-12—Arrises can take many shapes.

In all instances, the most effective design, along with efficient connection details, can be achieved by discussing these aspects with the precaster prior to finalizing the plans. They will be able to supply suggestions and designs that ensure that the maximum design efficiency is achieved at the lowest erected cost.



# Great Potential In Precast Bullnoses

Architect Anthony J. Lumsden explains a variety of ways he has used precast concrete bullnose components to give projects more aesthetic appeal

Many of the buildings I've designed as principal for design at DMJM and now as principal for Anthony J. Lumsden & Associates have incorporated precast linear elements that are rounded in section. Often, these precast pieces are designed with combinations of concave, convex and flat sectional shapes. Taking advantage of precast's plasticity in creating these shapes can add considerable aesthetic appeal to a project.

Bullnoses help add interest to many flat surfaces, especially those with no functional need or a minimal need for fenestration. These flat areas often lack scale and visual interest, and the introduction of bullnose precast sections can enliven them.

## Bullnoses Add Dimension

Their key advantage comes from the fact that three dimensional pieces that extend from a flat surface change the reading and proportion of that surface. Rectilinear shapes added to a flat plane may make the flat plane appear irregular and be visually disruptive. Curved surfaces, such as bullnoses, won't confuse the

organization of the total form. Their curved form offers a basically different shape in the geometry that is easily distinguished from the flat plane. The plane and the bullnose can modify each other without confusion.

Curved surfaces change direction in relationship to sunlight and the viewer.

Surfaces which change directions in plan or section relative to any light source, even

reflective light, express variations in illumination, reflectivity, shading and brightness. These light and shade variations produce visual interest and contrast. The sun's movement during the day introduces additional modification to this light and shading further changing the building's appearance. The fundamental appeal of the bullnose form in precast concrete design comes from its ability to visually reportion an uninteresting, flat surface.

The bullnose can also be used to develop more complex forms in combination with bullnose shapes of different radii or in combination of convex, concave or flat surfaces. Some architectural forms that are not flat can be difficult to achieve. However, forms which are cylindrical in nature, forms that have surfaces generated from a sectional shape which are consistent throughout the length of the form, are simple to form. These forms that are consistent sectionally allow multiple castings. These forms are economical to fabricate since attached pieces are identical and easy to install. Molded shapes that have curvatures about both axes are very difficult to fabricate, difficult to install and have limited repetitive



*Adding bullnoses along each window ledge of the Terminal Services Building at the Hyperion Wastewater Treatment Facility added variety to the design, improved the proportions of the facade, and created changing light patterns during the day.*



*The use of the bullnose sections on various support buildings at the Hyperion Wastewater Treatment Facility broke up the flat-panel facade and created a distinctive look.*



*Large bullnose components added to the parking structure at the Hyperion Wastewater Treatment Facility provided a distinctive visual element that tied it to the other buildings in the project without mimicking their exact look.*

applications. Forms which vary in radii in both axes, such as a warped plane, are extraordinarily expensive in fabrication and virtually impossible to install and maintain. This difference in reuse of the mold and ease of fabrication and installation is what distinguishes the bullnose form from many other nonlinear type forms.

The essence of the barrel form, which is basically a sliced extrusion, is that it can be fabricated and attached to a similar precast element simply and economically. Concrete allows for the economic use of three-dimensional forms that would be prohibitively expensive if they were cut from stone. Precasting allows these forms to be precisely controlled in accuracy of surface, shape and line and in consistency of color and texture.

## Facility Offers Examples

This combination of sectional geometries that extends horizontally to develop linear forms can be seen extensively on the Hyperion Wastewater Treatment Facility in Los Angeles. Bullnoses were designed under the windows at each floor level of the Technical Services Building. This changed the proportion of the opaque section of the facade, adding highlights on the upper curvature, shadows on the lower portions of the curved bullnose and shading on the flat spandrel surface.

The inclusion of bullnoses in the design illustrates how a surface can be modified to become better proportioned, more interesting and more visually organized. The bullnose design was used on a variety of other buildings in this project, including the Switchyard Building, the parking structure and several smaller support buildings on the Hyperion campus. This not only added visual interest but offered a continuity element that tied the separate structures together without mimicking one style.

On the Moscone Convention Center in San Francisco, the bullnose was used at the entry lobby interspersed with glazing and for the terraced garden on the 3rd Street facade. It was used to cap the planters and modify the proportion of the opaque service node.

These examples show only a few of the ways that bullnoses can provide design interest on a project. Its ability to break up the flat plane without disrupting its flow makes the bullnose a valuable weapon in the designer's arsenal of precast concrete design techniques.



*The lobby facade of the Moscone Convention Center makes ample use of bullnose sections, tying in with planters and adding visual interest to the center. (For another view of this project, see the Designer's Notebook cover, page 13.)*